

***FLEXI-HEX***<sup>®</sup> ***Air***

→ **Flexi-Hex<sup>®</sup> Air Sleeve - 35cm**

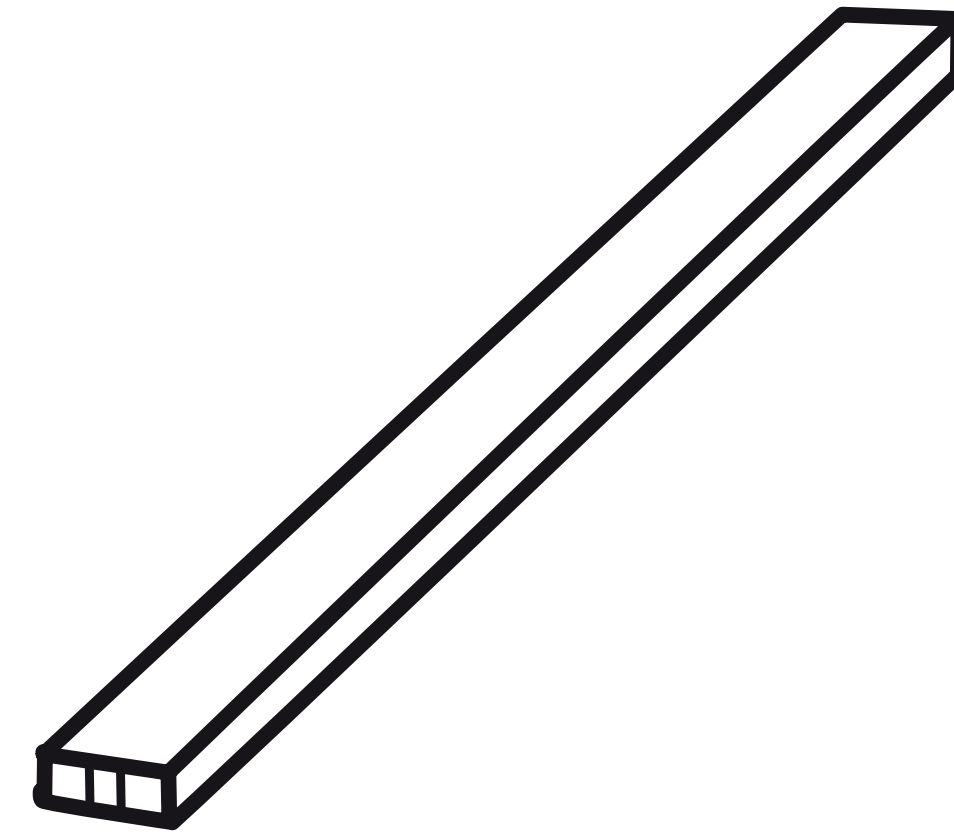

## Overview

A lightweight honeycomb sleeve made from high-quality tissue paper that helps protect small fragile items in transit. Renowned for its strength, the innovative hexagonal cell structure not only provides an incredible layer of protection; it also creates a flexible sleeve that is ideal for cosmetic bottles, electronic devices and glassware.

## Details

- Designed for the safe shipping of small lightweight fragile items
- Made from high quality tissue paper
- Plastic-free, kerbside recyclable, home compostable and biodegradable
- Quick and easy to assemble
- Lightweight and compact for cost-effective shipping and storage
- Strong, flexible and adaptable; expands and forms around products of all shapes and sizes (up to 350mm wide)
- Sleeves can easily be cut down to size
- Can be customised with company branding
- An aesthetic e-commerce solution which adds brand value and improves the customer unboxing experience
- Available in 3 other sizes: 10cm, 20cm, 25cm
- Boxes, caps and wraps sold separately

## Product Information

### NAME

Flexi-Hex® Air Sleeve - 35cm

### SKU

AIR-KRA-35

## Specification

### SLEEVE UNIT

350mm L x 25mm W x 12mm H

### EXPANDED DIMENSIONS

Max 350mm

### BOX DIMENSIONS

723 x 393 x 255mm

### WEIGHT

60g

36.7kg

### QTY PER BOX

600pcs

## Pallet info

### DIMENSIONS

1200 x 800 x 1110mm\*

### WEIGHT

460kg  
approx\*

### QTY

7,200\*

## Material

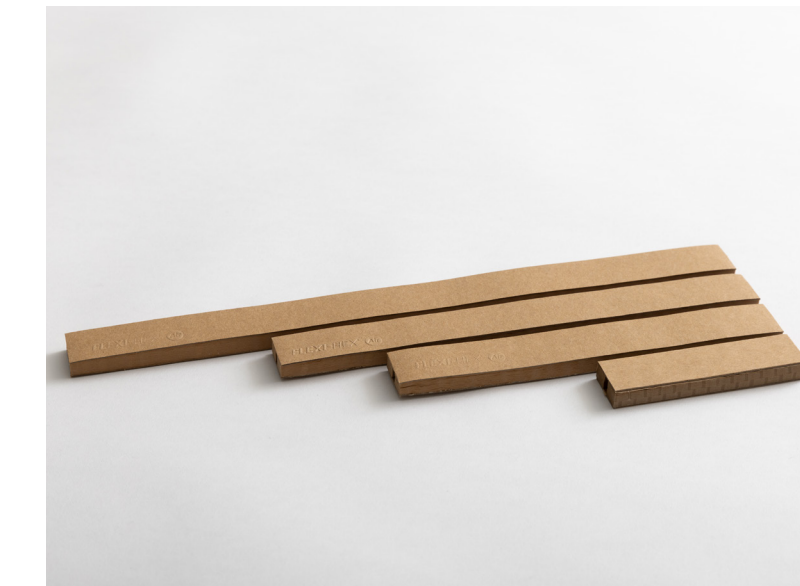

45gsm tissue paper, 100% recyclable and biodegradable.

Kraft sleeve is made from over 76% recycled content.

\*qty and dims may vary, please check on ordering

DATA SHEET - FLEXI-HEX AIR 35CM

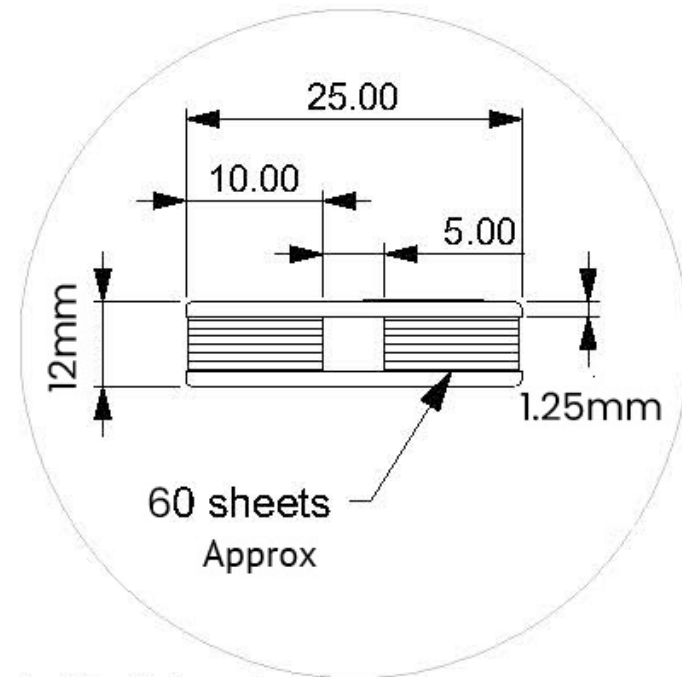

1:1 End view detail

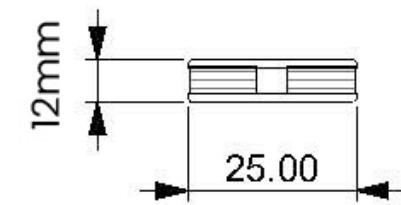

End view  
(Section)

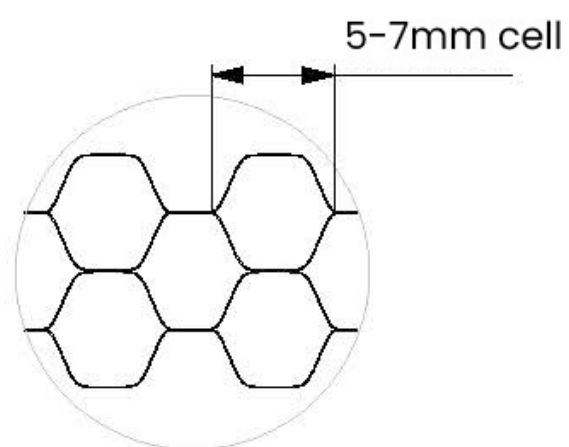

Cell detail

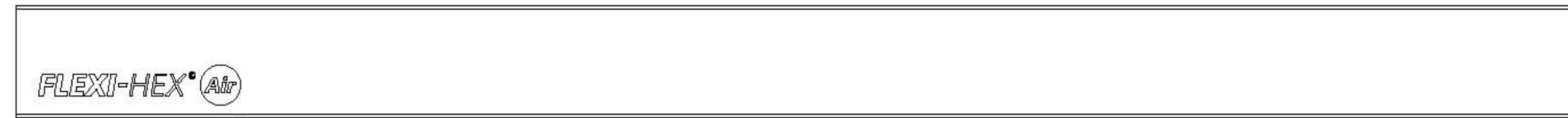

Embossed logo

Plan view

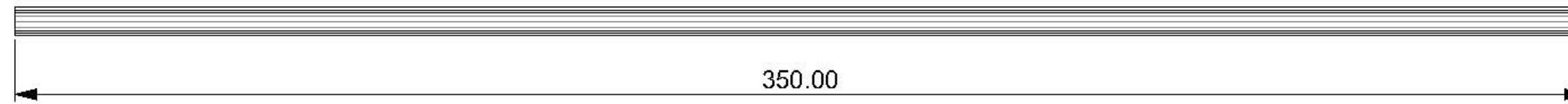

Side view

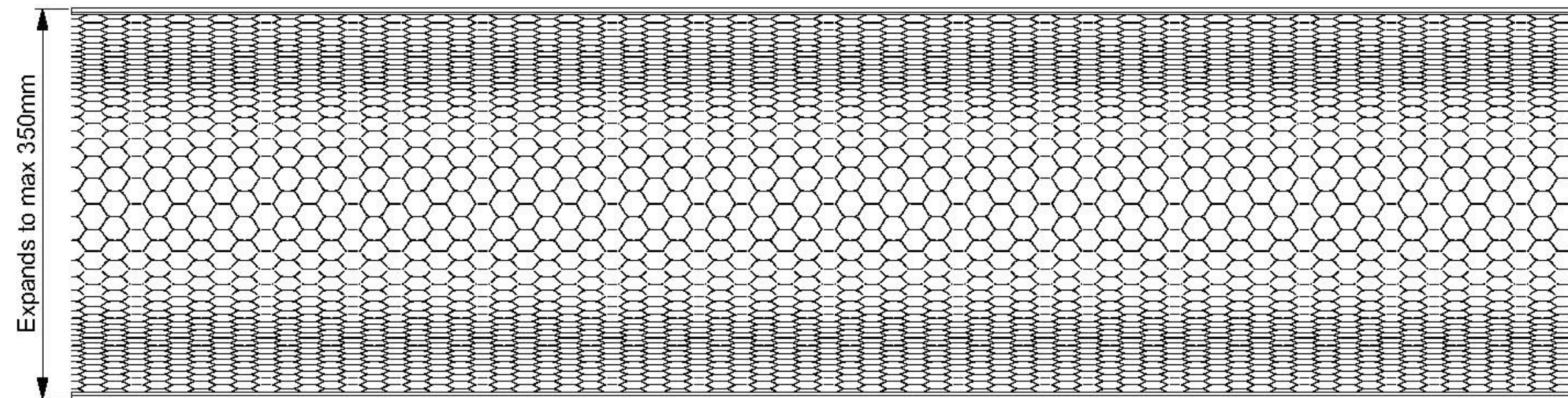

Expanded sleeve

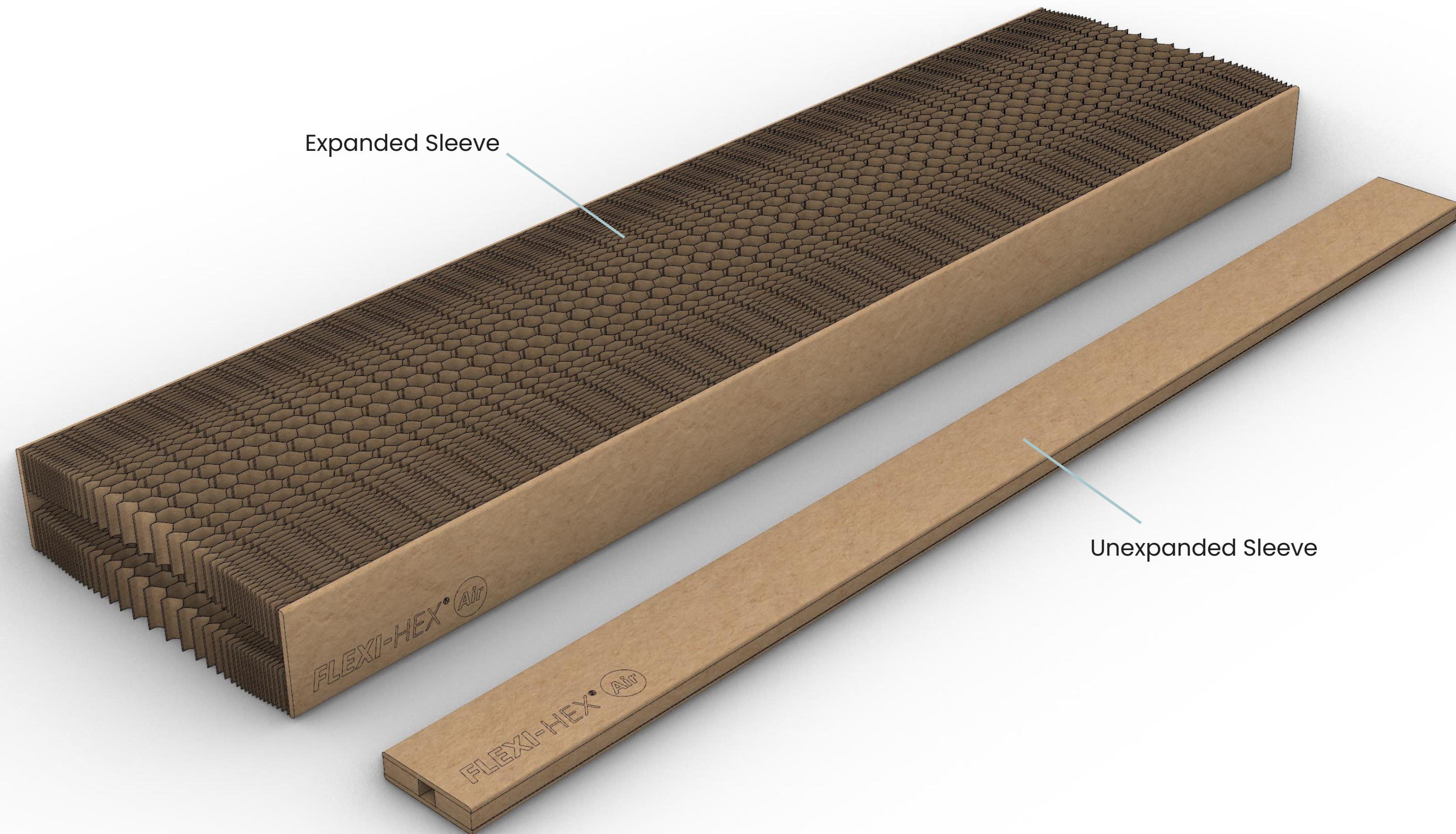

DATA SHEET - FLEXI-HEX AIR 35CM

